

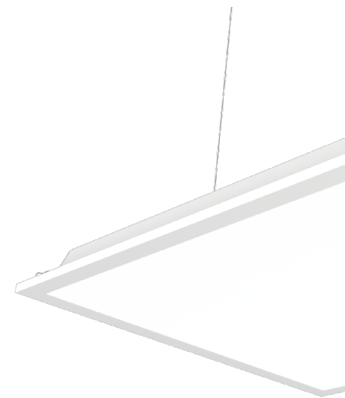

ilumen



Product Collection 2026



WE MAKE IT
Light
GERMAN QUALITY · DEUTSCHE QUALITÄT

ilumen

About ilumen



Ilumen brand, part of an ISO 9001:2015 certified LeuchteK GmbH group, was founded in 2007 with main headquarters, production lines and R&D team located in Ahrensburg, Germany. LeuchteK GmbH Group has hundreds of employees around the world and has official representatives in European countries.

Ilumen brand is focused on professional and technical lighting and has over 15 years of experience in the LED lighting industry with wide range of top-quality LED products for both Indoor and Outdoor use. All our products designed and developed by our R&D team and tested by our laboratory.

What we offer

As an innovation pioneer, ilumen offers wide range of high quality lighting solutions, including industrial lighting, outdoor lighting and indoor lighting etc.



Industry



Sport Fields



Routes



Chemical Plant



Residential



Parking lots



Office



Warehouse

RESEARCH AND DEVELOPMENT (R&D)

The development team of ILUMEN is composed of skilled engineers and designers dedicated to innovation and technological advancement. They work collaboratively to create cutting-edge lighting solutions, integrating energy-efficient designs and smart technology.

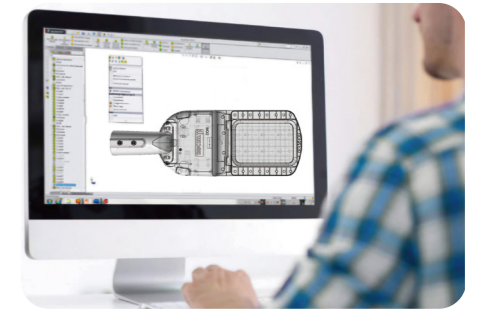

LABORATORY & TESTING

ILUMEN laboratory performs various tests such as electrical tests, goniophotometers test (IES) luminaire efficacy, color rendering index (CRI), correlated color temperature (CCT) etc. Our products complied with all DIN standards as well as European directives and quality norms, including CE, SAA, ERP, ROHS.



PRODUCTION LINE

Fully automated production lines, equipped with cutting-edge technology to ensure efficiency and precision. Streamline the manufacturing process enabling high-quality LED lighting solutions with minimal human intervention.



QUALITY CONTROL

ILUMEN implements quality control (QC) procedures to ensure our products meet the highest standards of performance and reliability. Each stage of production undergoes thorough inspection, including component testing, automated optical verification, and durability assessments.



PRODUCTS CONTENTS

INDOOR

Down Light

Pages 7-8



MILA



ANNA

Panel Light

Pages 9-14



ELKA

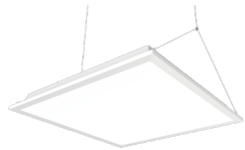

EMILIA



EMILIA CR

Triproof Light

Pages 15-20



ADELE



AVA



EMMA

High Bay

Pages 21-26



LINA



LAURA



MATILDA

OUTDOOR

Flood Light

Pages 27-28



KLOSE

Sport Light

Pages 29-32



KROOS



DRAXLER

Street Light

Pages 33-38



MULLER



LIAM



AGNES

Tunnel Light

Pages 39-40



TUNNELUM

Mila

Down Light



Versatile, flexible and timeless, Mila is the ideal solution for a wide range of applications.

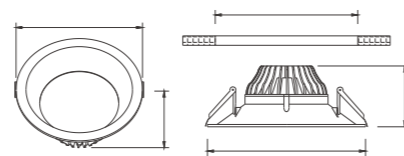
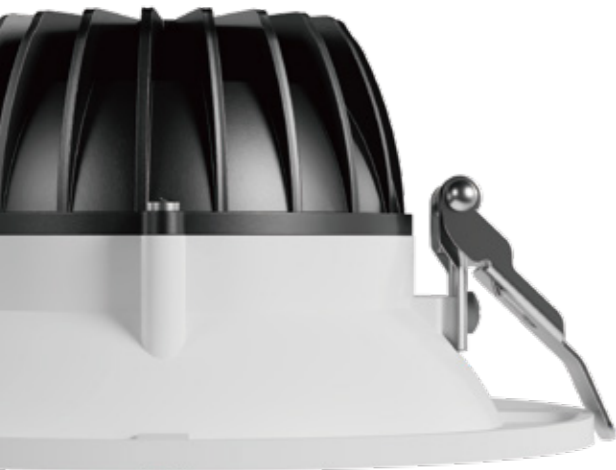

	Ø	H	Cut Out
12W	160	80	130
20W	190	90	165
30W	230	95	200

Dimensions(mm)



Product Parameter

Model Number	IL-DL17-NXXX3C-100
Power	12W/20W/30W
Luminous Flux	1320Lm/2600Lm/4050Lm
Ra	>90
UGR	<26 (<19 optional)
Light Efficiency	135lm/W
Input voltage	220-240Vac
Color Temperature	2700K/3000K/4000K
Operating Temperature	-10°C to +40°C
Ingress protection code	IP54
Beam angle	100°
SDCM	<3
LED Lifespan	80,000Hrs@L80B10 (Ta 25Deg)
Body materials	ADC 12
Diffuser	PMMA
Color	White+Black
Mounting options	Recessed
Intelligent control	0-10V/DALI

Elka

Panel light



SMART CONTROLS

WITH THE OPTIONAL MICROWAVE SENSOR (MWS). The Elka gains motion switch functionality. No need to remember to turn the lights off. This can turn the panel on when movement is detected within a space, and turn it off again after a pre-selected hold-time when motion ceases.

SUPER SLIM

The thickness of Elka is only 18mm, ideal for lay-in ceilings and help reduce space when it's loaded in container, so that you can save more shipping cost.

HIGH LUMEN OUTPUT

Elka features that it's made of reflector that allow glare control (UGR<19) even at very high lumen output. Besides, opal cover solution is also available.

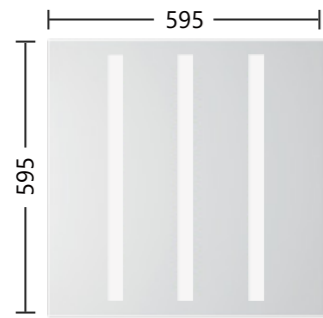

Optics: Opal cover

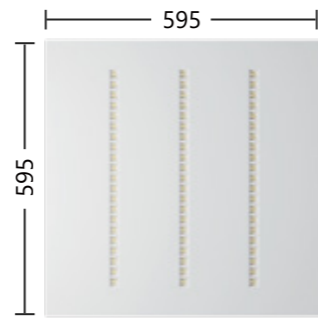

Optics: Reflector cover



Product Parameter

Model Number	Opal IL-PL20-NXXX40-110	Reflector IL-PL20-NXXX40-75
Power	36W/40W/48W	36W/40W/48W
Luminous Flux	3500LM/4000LM/4400LM	5000LM/5300LM/6200LM
Ra	80	80
UGR	<22	<19
Light Efficiency	100LM/W	140LM/W
Input voltage	220-240Vac	
Color Temperature	2700K/3000K/4000K	
Operating Temperature	-10°C to +40°C	
IP/IK rating	IP20/IK05	
Beam angle	110°/75°	
SDCM	<3	
LED Lifespan	80,000Hrs@L80B10 (Ta 25Deg)	
Body materials	SPCC	
Lens& Reflector	PC	
Color	Powder coated in white RAL9003	
Mounting options	Lay-in ceilings/Recessed/Suspended /Surface mounted	
Intelligent control	0-10V/DALI/Microwave sensor/PIR sensor/Bluetooth	

Emilia

Panel light

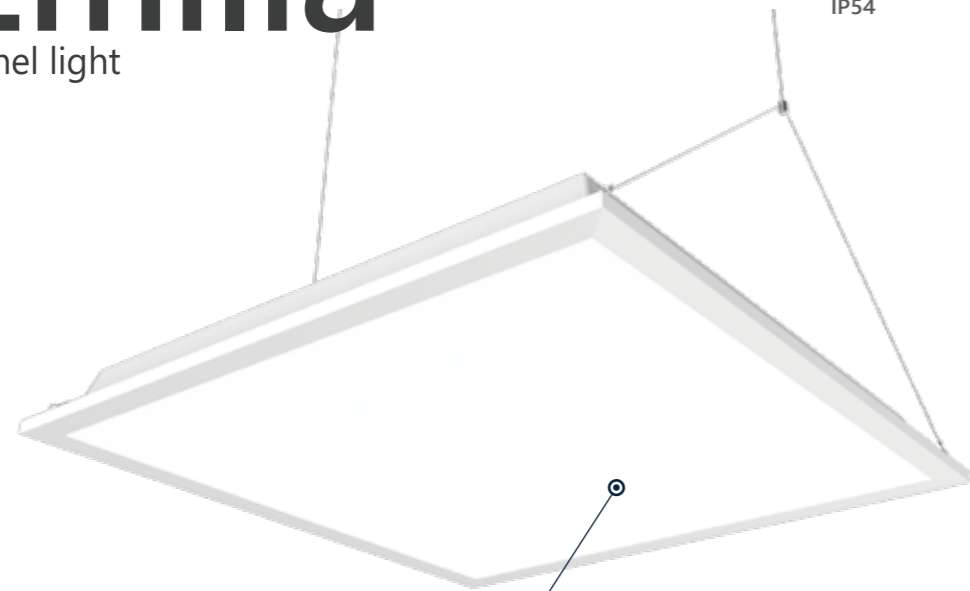

63.5mm HEIGHT

Guarantee the better uniformity even when it's made in high power and high lumen output.



OPAL OPTIC
Give a gentle, uniform appearance, with an easy-to-clean surface

HIGH LUMEN OUTPUT

High lumen output up to 6000lm.

IP54 WATER-PROOF

Frontside: IP54, Backside: IP20.
It can be installed in more locations.

MICROPRISMATIC OPTIC
Reduce glare and relieve eye fatigue (UGR<19)

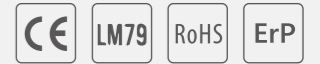
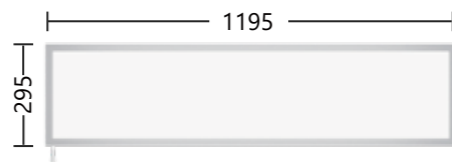
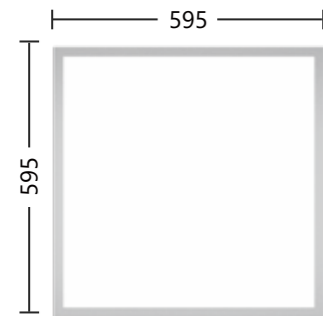

Product Parameter

Model Number	IL-PL16-NXXX40-110
Power	36W/40W/48W
Luminous Flux	4900LM/5400LM/6000LM
Ra	80/ 90
UGR	<22, (<19 optional)
Light Efficiency	Up to 140lm/W
Input voltage	220-240Vac
Color Temperature	2700K/3000K/4000K/4500K
Operating Temperature	-10°C to +40°C
Ingress protection code	Frontside: IP54, Backside: IP20
Beam angle	100-110°
SDCM	<3
LED Lifespan	80,000Hrs@L80B10 (Ta 25Deg)
Panel backplate integrated	SPCC
Lens	PMMA
Body	Powder coated in white RAL9003
Mounting options	Lay-in ceilings/Recessed/Suspended /Surface mounted
Intelligent control	0-10V/DALI/Microwave sensor/PIR sensor/Bluetooth

Emilia CR

Panel light

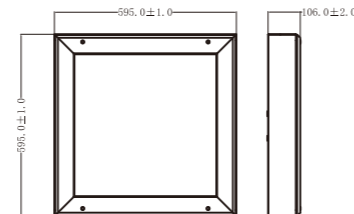
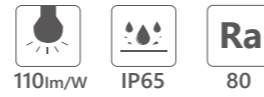

① Thermoformed PMMA Cover

Developed in accordance with GMP hygiene guidelines. The outer frame features a chamfered design to prevent dust accumulation and bacterial growth. It includes a sealing gasket for dust and water protection. Screw holes on the surface allow for quick access and easy removal of the cover.

② PCB Gear Plate

Firmly secured to the base with screws, this design allows for easy disassembly, assembly, and maintenance of the middle section.

③ Powder-coated steel housing

Offer strong corrosion and oxidation resistance. Features a key-lock clip design to ensure each parts is securely connected without compromising the lighting performance.

Product Parameter

Model Number	IL-PL32-NXXX40-110
Power	36W/40W/48W
Luminous Flux	3960LM/4400LM/5280LM
Ra	80
UGR	<22
Light Efficiency	110LM/W
Input voltage	220-240Vac
Color Temperature	3000K~6500K
Operating Temperature	-20 to +45°C
Ingress protection code	IP65
Beam angle	110°
Mech. impact protection code	IK03
SDCM	<3
LED Lifespan	60,000Hrs@L80B10 (Ta 25Deg)
Base plate	SPCC
Lens	PMMA
Color	Powder coated in white RAL9003
Mounting options	Lay-in ceilings/Recessed/Suspended /Surface mounted
Intelligent control	0-10V/DALI/Microwave sensor/PIR sensor/Bluetooth

Adele

Triproof Light



POWER SELECTABLE & CCT SELECTABLE OPTIONAL

--When you turn on this button, you can adjust the power or color temperature to help you reduce SKU.

THREE-PHASE WIRING OPTIONAL

--Simple structure, low cost, reliable operation, and easy maintenance by using jumper cables and connector to wire.

--More economical than single-phase transformers and are easier to connect to loads.

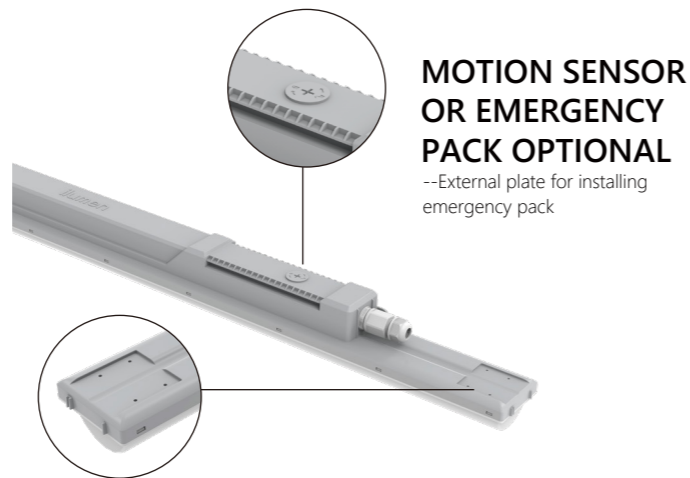

MOTION SENSOR OR EMERGENCY PACK OPTIONAL

--External plate for installing emergency pack

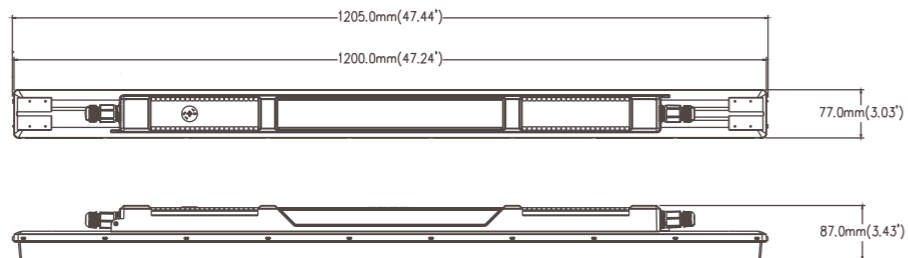

Product Parameter

Model Number	IL-TL15-NXXX(P)40-XXX
Power	12W/16W/20W 24W/32W/40W 30W/40W/50W
Luminous Flux	1920lm-7500lm
Ra	>80
Light Efficiency	150lm/w
Input voltage	220-240Vac
Operating Temperature	-30~45°C
Ingress protection code	IP69K
Mech. impact protection code	IK10
Beam angle	120°
SDCM	<3
LED Lifespan	100,000Hrs@L80B10 (Ta 25Deg)
Color	White
Mounting options	Hoisting/ Ceiling mounted / Wall mounted
Intelligent control	0-10V/DALI/Microwave sensor

Ava

Triproof Light

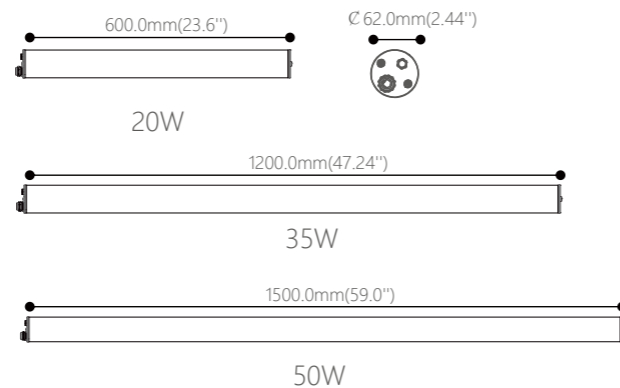

With smooth surface and seamless structure, Ava can **eliminate the risk of accumulation of water, dust and bacteria.**

Product Parameter

Model Number	IL-TL27-NXXX40-120
Power	20W/35W/50W
Luminous Flux	2200lm~7000lm
Ra	80
Light Efficiency	110lm/W, 120lm/W, 130lm/W, 140lm/W
Input voltage	220-240Vac
Operating Temperature	-25°C ~ 50°C
Ingress protection code	IP69K
Mech. impact protection code	IK10
Beam angle	120°
SDCM	<3
LED Lifespan	80,000Hrs@L80B10 (Ta 25Deg)
Color	Grey base/Transparent & striped cover
Mounting options	Hoisting/ Ceiling mounted / Wall mounted
Intelligent control	0-10V/DALI/Microwave sensor

Emma

Triproof Light

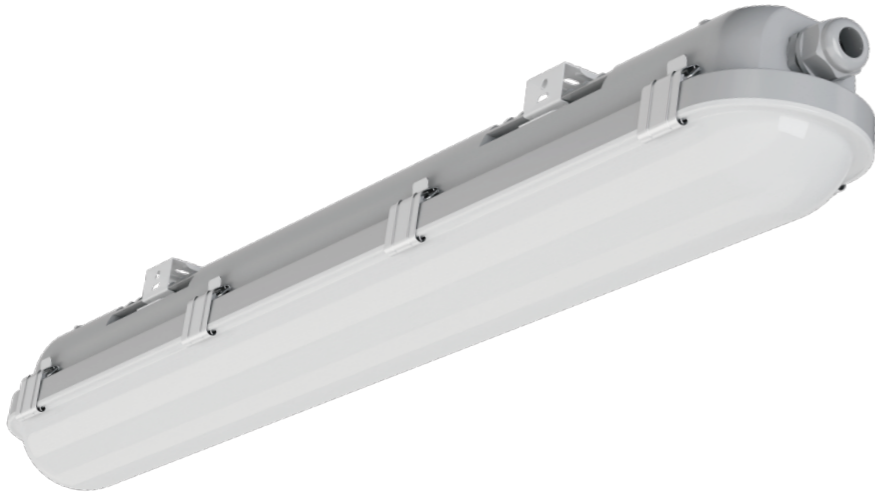
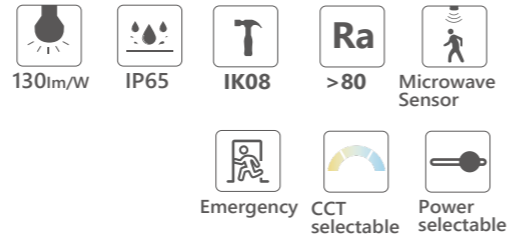

Power selectable & CCT selectable optional

In order to quickly match different projects, Emma is designed to allow the end users adjust the color temperature and powers by DIP switches according to the real needs on site, which will also reduce the inventory greatly.

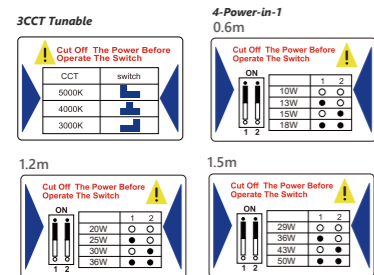

Serial connection is optional

0.6m	90pcs	Standard
1.2m	45pcs	Serial Link
1.5m	30pcs	Serial Link

DALI, Microwave Motion Sensor And Emergency Pack as Options.

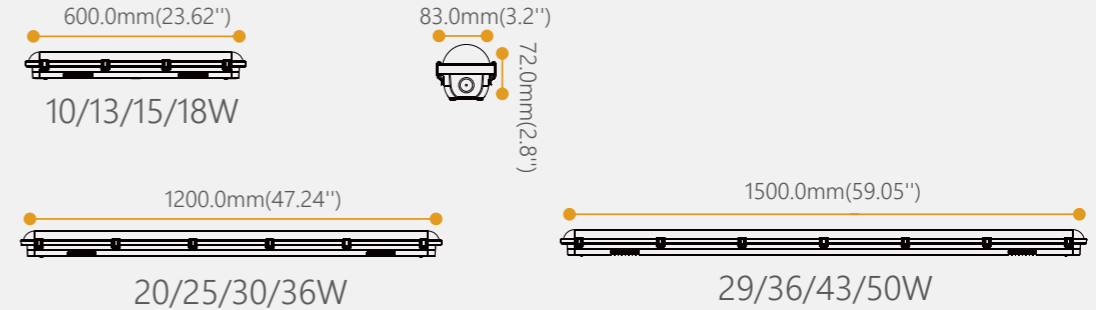







Product Parameter

Model Number	IL-TL26-NXXX40-120		
Power	10/13/15/18W	20/25/30/36W	29/36/43/50W
Luminous Flux	1300lm~6500lm		
Ra	80		
Light Efficiency	130lm/W		
Input voltage	220-240Vac		
Operating Temperature	-10°C ~ 40°C		
Ingress protection code	IP65		
Mech. impact protection code	IK08		
Beam angle	120°		
SDCM	<3		
LED Lifespan	100,000Hrs@L80B10 (Ta 25Deg)		
Color	Grey base/Transparent & striped cover		
Mounting options	Hoisting/ Ceiling mounted / Wall mounted		
Intelligent control	0-10V/DALI/Microwave sensor		

Lina

High Bay Light

-  Up to 150lm/W
-  IP65
-  IK08
-  Ra >80
-  Microwave Sensor
-  3 beam angle adjustable
-  Power selectable



ACCESSORIES

--Two Reflectors available



PC Cover



AL Cover

--Mounting options (Suspending chain, Bracket)



Suspending chain



Bracket

ADJUSTABLE BEAM ANGLE

Buy one get three, that is, there are three beam angles on one model. It highly helps to save SKU and inventory cost.



SMART CONTROL OPTINAL

-  Bluetooth module
-  ZigBee module
-  Microwave motion sensor module & Photoreceptor sensor module
-  Daylight harvest sensor module

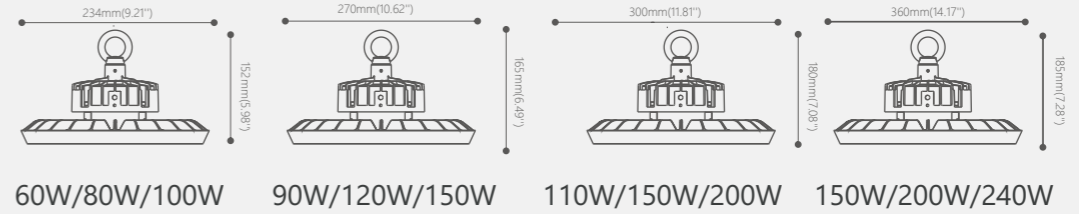
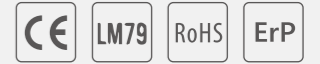

Product Parameter

Model Number	IL-HB12-L10040-XXX	IL-HB12-L15040-XXX	IL-HB12-L20040-XXX	IL-HB12-L24040-XXX
Power	60W/80W/100W	90W/120W/150W	110W/150W/200W	150W/200W/240W
Luminous Flux	15000lm	22500lm	30000lm	36000lm

Ra	>80
Light Efficiency	150lm/w
Input voltage	220-240Vac
Operating Temperature	-30°C to +45°C
Ingress protection code	IP65
Mech. impact protection code	IK08
Beam angle	60°/90°/105°
SDCM	<5
LED Lifespan	80,000Hrs@L80B10 (Ta 25Deg)
Color	Powder Black RAL9017
Lens	PC
Mounting options	Suspending / Ceiling Mounting / Wall Mounting
Intelligent control	0-10V/DALI/Microwave sensor/Zhaga

Laura

High Bay Light



Special design & shape

Laura typically has a square or rectangular housing, providing a modern and sleek appearance. The square design ensures even light distribution and efficient coverage of large areas.



Durability and Build Quality

Constructed with robust materials such as aluminum for heat dissipation and longevity. Often rated IP65 for dust and water resistance, making them suitable for wet environments.

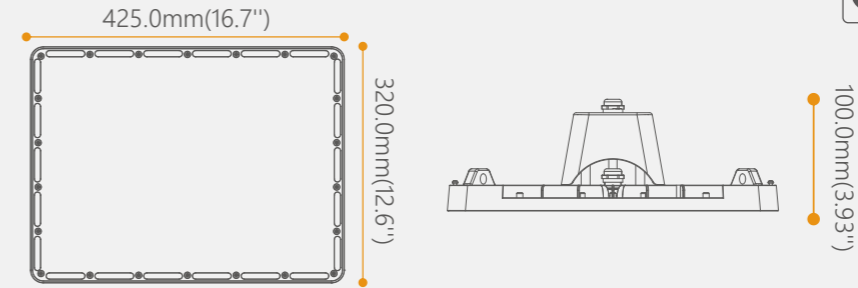

Product Parameter

Model Number	IL-HB25-N10040-75	IL-HB25-N15040-75	IL-HB25-N20040-75
Power	100W	150W	200W
Luminous Flux	16500lm	24750lm	33000lm
Driver	OSRAM		
Ra	80		
Light Efficiency	165lm/W		
Input voltage	220-240Vac		
Operating Temperature	-30°C to +50°C		
Ingress protection code	IP65		
Beam angle	75°		
SDCM	<5		
LED Lifespan	80,000Hrs@L80B10 (Ta 25Deg)		
Lens materials	PC		
Color	White		
Mounting options	Suspending/Ceiling mounted with bracket		
Intelligent control	0-10V/DALI/Microwave sensor		

Matilda

High Bay Light



Tool-free wiring and installation

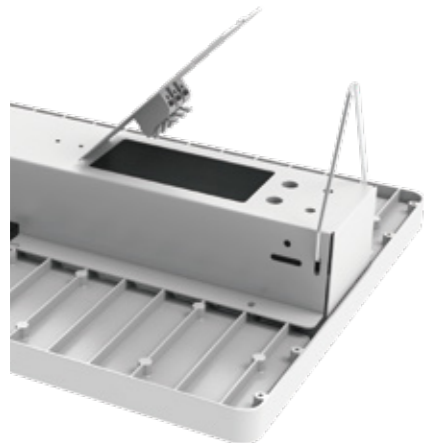

IP65 rating for front side of fixtures.

DIP switch, 3-power-in-1 (100W/150W/200W)



Product Parameter

Model Number	IL-HB23-N10040-XXX	IL-HB23-N15040-XXX	IL-HB23-N20040-XXX
Power	100W	150W	200W
Luminous Flux	16000lm	23250lm	30000lm
Ra	>80		
Light Efficiency	160lm/w		
Input voltage	220-240Vac		
Operating Temperature	-30°C to +50°C		
Ingress protection code	IP65 (Front side), IP54 (Back side)		
Beam angle	90°/110°/30*110°		
SDCM	<5		
LED Lifespan	80,000Hrs@L80B10 (Ta 25Deg)		
Color	Powder white		
Lens materials	PC/PS		
Mounting options	Suspending/Ceiling mounted with bracket		
Intelligent control	0-10V/DALI/Microwave sensor/Zhaga		

Klose

Flood Light

-  Up to 160lm/W
-  IP66
-  IK08
-  Ra > 70
-  Power selectable



Superb heat dissipation to ensure long life span.



- 
- 
- 
- 

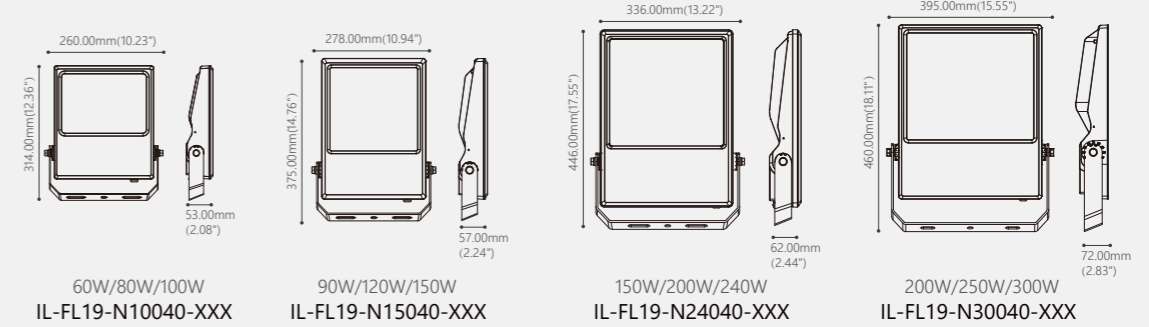

Product Parameter

Light and Electrical

LED Chip	Lumileds
Light Efficacy	150lm/w, 155lm/w, 160lm/w
CCT	3000K~6500K
CRI	70/ 80
LED Lifespan	80,000@L80B10 (Ta 25Deg)
Driver	Philips
Input voltage	220-240Vac
Input Frequency	50/60Hz
Inrush current	-
Power Factor	>0.95
THD	-
SPD	-
CLASS	I

Controls and Dimming

Dimmable	Non-dimmable,0-10V dimmable
Intelligent Control	-

Mechanical and Housing

Structure Material	ADC12
Finish Material	Powder coated
Lens Material	Tempered glass only / PC Lens+Tempered glass
Glass Material	-
Fixture Color	Black
Mouting Option	Ground /Wall Mounted

Photometric distributions

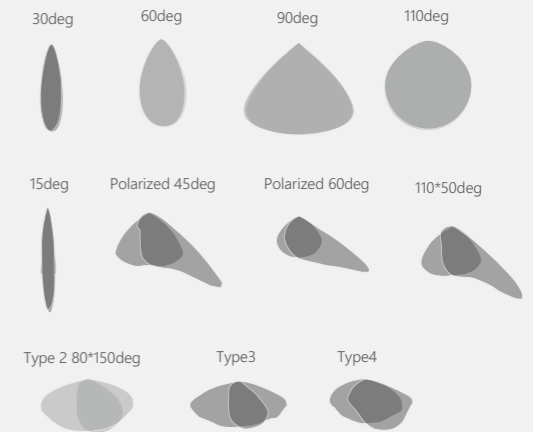

Operating Temperature

Operating Temperature	-30°C~+50°C
-----------------------	-------------

Kroos

Sport Light

-  Up to 160lm/w
-  IP66
-  IK08
-  Ra >70



Bending bracket 0-180° stepless adjustable projecting direction



- 
- 
- 
- 

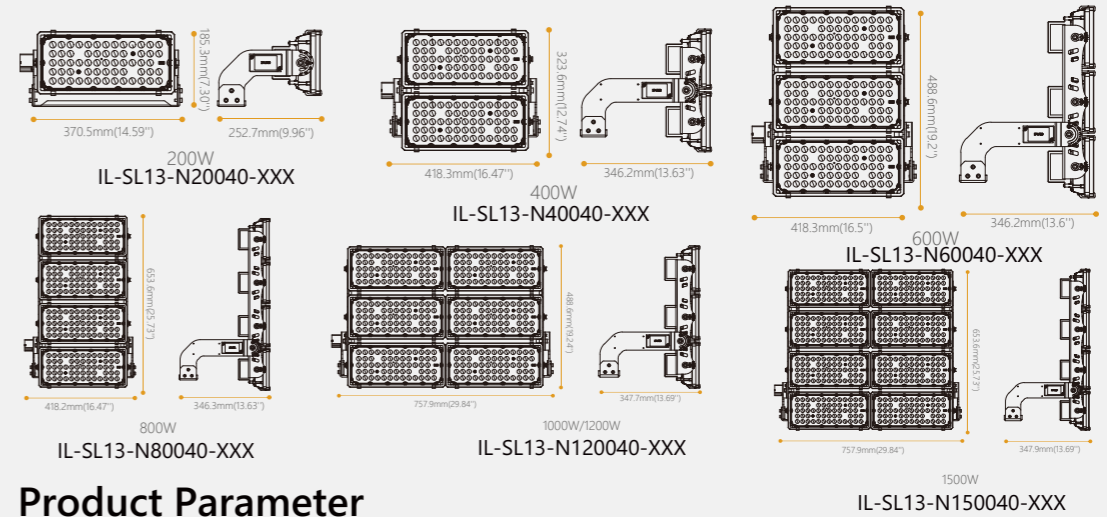

Product Parameter

Light and Electrical

LED Chip	Lumileds
Light Efficacy	145lm/w, 150lm/w, 160lm/w
CCT	3000K~6500K
CRI	70/ 80
LED Lifespan	100,000Hrs@L80B10 (Ta 25Deg)
Driver	Philips
Input voltage	220-240Vac
Input Frequency	50/60Hz
Inrush current	-
Power Factor	>0.95
THD	-
SPD	-
CLASS	I

Photometric distributions

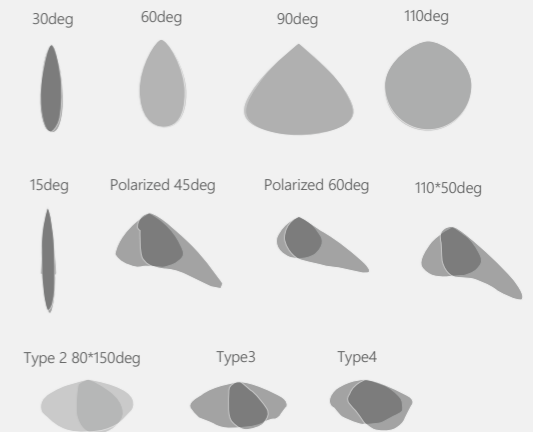

Controls and Dimming

Dimmable	Non-dimmable, 0-10V dimmable
Intelligent Control	-

Operating Temperature

Operating Temperature -30°C~+50°C

Mechanical and Housing

Structure Material	ADC12
Finish Material	Powder coated
Lens Material	Tempered glass only / PC Lens+ Tempered glass
Glass Material	-
Fixture Color	Black
Mouting Option	Ground /Wall Mounted

Draxler

Sport Light

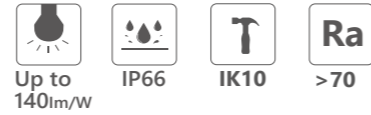

A variety of professional accessories are available.

Precision Aiming/Wireguard/Visor/DMX512 converter
Visor to trim the excess upward light. The focused beam reduces light spillover into surrounding areas, ensuring compliance with lighting regulations and minimizing disturbance to nearby environments, reducing light pollution.



Rotatable Bracket, allows 180 degree rotation.

The readable adjustment scale printed on the bracket enables precise installation and reduces the luminaire quantities for cost-saving.



High-level impact protection (IP66 & IK10)

Sealed and gasketed for IP66 protection rating to prevent dirt and water from outsiders. PC lens protect it from impact, both of which enables Draxler to be used for harsh outdoor wet locations.

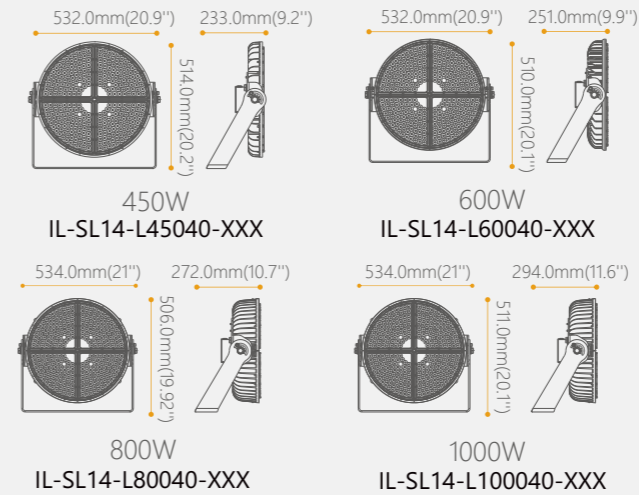

Product Parameter

Light and Electrical

LED Chip	SAMSUNG 351B
Light Efficacy	140lm/W, 130lm/W, 120lm/W
CCT	4000K/ 5000K/ 5700K
CRI	70
LED Lifespan	100,000Hrs@L80B10 (Ta 25Deg)
Driver	Philips
Input voltage	220-240Vac
Input Frequency	50/60Hz
Inrush current	-
Power Factor	≥0.9
THD	≤20%
SPD	10KV/20KV (optional)
CLASS	I

Photometric distributions



Controls and Dimming

Dimmable	Yes
Intelligent Control	0-10V Dimming, DMX512, DALI

Operating Temperature

Operating Temperature -30°C ~ +50°C

Mechanical and Housing

Structure Material	Die-cast Aluminum EN ADC-12
Finish Material	Powder coated
Lens Material	(PC) Polycarbonate
Glass Material	-
Ingress protection code	IP66
Mech. impact protection	IK10

Muller

Street Light

150lm/W
 IP66
 IK08
 CRI >70
 CCT selectable
 Power selectable



Power selectable & 3 CCT selectable

Smart Control optional
 Photocell/3Pin/5Pin/7Pin NEMA socket/Zhaga

PC lens+ Tempered glass

Buckle design for easy opening
 Tool-free access to electronic compartment with a snap fastener. Easy installation and maintenance.

Microwave sensor/Daylight sensor/Zigbee/Smart system optional to connect

Compatible with DALI driver, CLO/IoT function optional

Mounting angle: -15deg~+15-deg adjustable, vertical installation is available

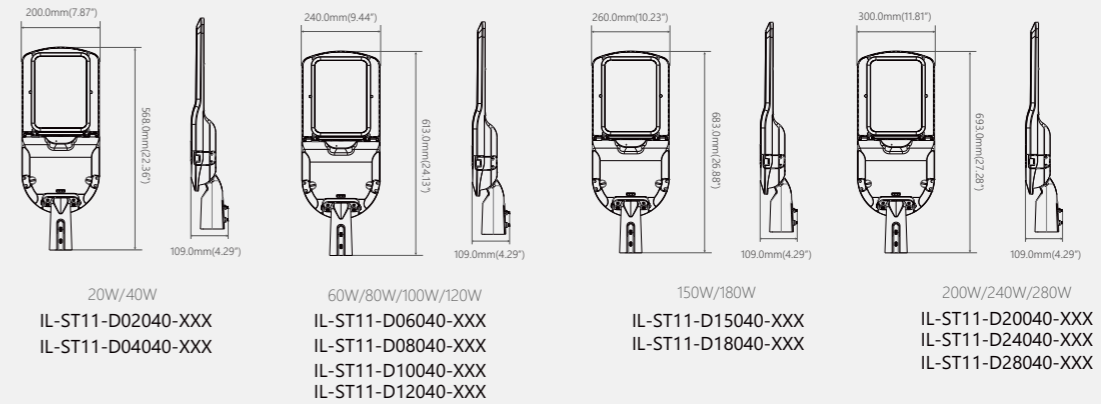

Product Parameter

Light and Electrical

LED Chip	Lumileds 5050 /Cree XPG
Light Efficacy	150lm/W
CCT	2700-6500K
CRI	>70 (80 optional)
LED Lifespan	100,000Hrs@L80B10 (Ta 25Deg)
Driver	Osram/Philips DALI
Input voltage	220-240Vac
Input Frequency	50/60Hz
Inrush current	-
Power Factor	>0.95
THD	<15
SPD	Osram/Philips 10KV
CLASS	I/II

Photometric distributions

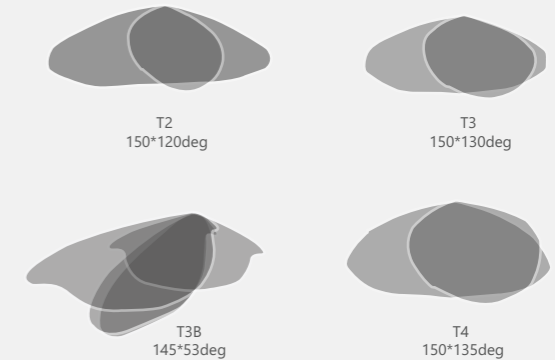

Controls and Dimming

Dimmable	Yes
Intelligent Control	1-10V Dimming/DALI/Daylight Sensor/Microwave Sensor

Operating Temperature

Operating Temperature -30°C~+50°C

Mechanical and Housing

Structure Material	Die-cast Aluminum EN AC-44100 with low copper
Finish Material	Polyester powder coat paint
Lens Material	Polycarbonate UV resistant
Glass Material	Tempered glass
Ingress protection code	IP66
Mech. impact protection	IK08

Liam

Street Light

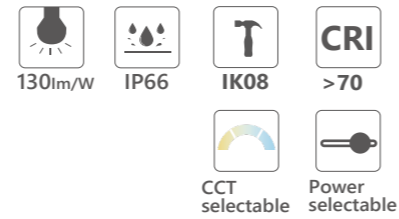

Max. 2% upward light emitted to sky compliant with DarkSky regulation.

Easy access to power/CCT switches by taking out a screw. (DIP switches which locates in the gear box)

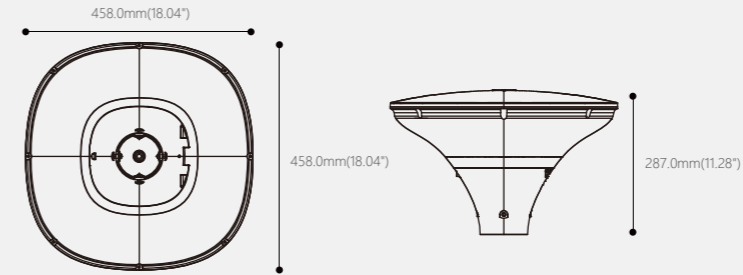

IL-PO30-NXXX2C-TY5

Product Parameter

Light and Electrical

LED Chip	Lumileds
Light Efficacy	130lm/W
CCT	3000K/4000K Selectable
CRI	>70 (80 optional)
LED Lifespan	80,000Hrs@L80B10 (Ta 25Deg)
Driver	Philips
Input voltage	220-240Vac
Input Frequency	50/60Hz
Inrush current	-
Power Factor	>0.95
THD	<15
SPD	Osram 10KV
CLASS	I

Photometric distributions



Type V

Controls and Dimming

Dimmable	Optional
Intelligent Control	1-10V dimming/DALI/Microwave sensor /NEMA/Zhaga

Operating Temperature

Operating Temperature	-30°C~+50°C
-----------------------	-------------

Mechanical and Housing

Structure Material	Die casting ADC12
Finish Material	Power coated paint RAL9017
Lens Material	(PC)Polycarbonate
Glass Material	/
Ingress protection code	IP66
Mech. impact protection	IK08

Agnes

Street Light

Agnes A

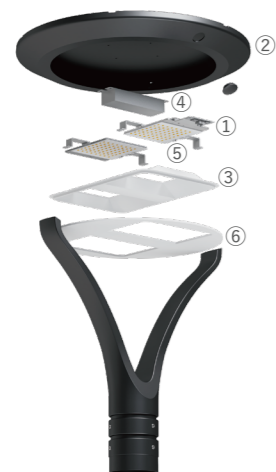

- ①: Plastic plug: Used to cover power & color temperature selectable switch.
- ②: Housing: Made of die-cast aluminum, it has excellent heat dissipation performance.
- ③: Reflective paper: Make the lighting effect of the lamps better and more uniform.
- ④: Driver & switch: To make it more user-friendly, Agnes is preset with power and color temperature settings. Users can select their desired power and color temperature individually via the switch.
- ⑤: Professional PCB with good heat conduction.
- ⑥: Tempered glass: Featuring strong impact resistance, high temperature tolerance, and enhanced safety, it also effectively prevents glare and UV radiation.

150lm/W	IP65	IK09	CRI >70
		CCT selectable	Power selectable

Agnes B



Agnes C



Agnes D



Agnes A
IL-PO29A-NXXX2C-XXX

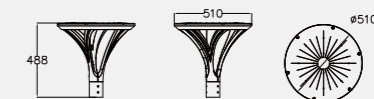

Agnes B
IL-PO29B-NXXX2C-XXX

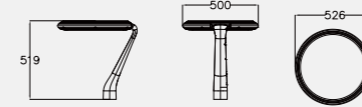

Agnes C
IL-PO29C-NXXX2C-XXX

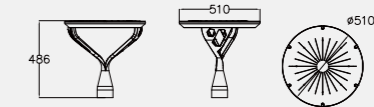

Agnes D
IL-PO29D-NXXX2C-XXX

Product Parameter

Light and Electrical

LED Chip	Lumileds
Light Efficacy	150lm/w
CCT	3000K/4000K selectable
CRI	>70 (80 optional)
LED Lifespan	80,000Hrs@L80B10 (Ta 25Deg)
Driver	Sosen/Philips
Input voltage	220-240Vac
Input Frequency	50/60Hz
Inrush current	-
Power Factor	>0.95
THD	<15%
SPD	Osram 10KV
CLASS	I

Photometric distributions

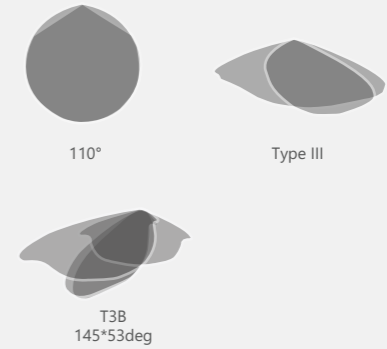

Controls and Dimming

Dimmable	Optional
Intelligent Control	1-10V dimming/DALI/Microwave sensor

Operating Temperature

Operating Temperature	-30°C~50°C
-----------------------	------------

Mechanical and Housing

Structure Material	Die casting ADC12
Finish Material	Power coated paint RAL9017
Lens Material	(PC)Polycarbonate
Glass Material	Tempered glass
Ingress protection code	IP65
Mech. impact protection	IK09

Tunnelum

Tunnel Light



Rugged die-cast aluminium construction: Guarantee durable performance and good heat dissipation.

Mounting Flexibility: Adjustable mounting angle from +5° to -15°



Supports NFC dimming: Three LED lumen packages available in 1078, 2252 & 3013 lumens.



Prismatic optics: Controlled light output & low glare

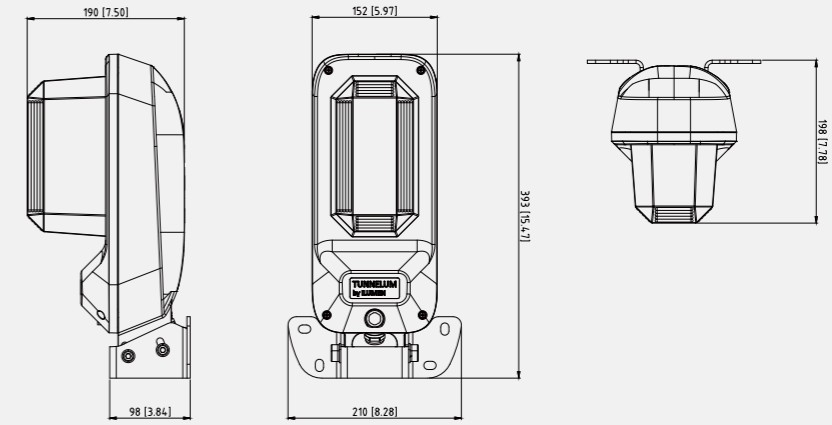

IL-TU34-NXXX40-TY5



PRODUCT DATA

Light and Electrical

LED Chip	Lumileds 2835
Light Efficacy	124lm/w
CCT	4000K (optional: 3000K/6500K)
CRI	80
LED Lifespan	80,000@L80B10 (Ta 25Deg)
Driver	Tridonic
Input Power	220-240VAC, 176-280VDC, 24W
Input Frequency	50/60/0 Hz
Inrush Current	14.88 A / 226 µs
Power Factor	≥0.92
THD	<20%
SPD	L-N:6KV, LN-GND:10KV
CLASS	II
Risk Group	RG0

Photometric distributions

Type V



Operating Temperature

Operating Temperature -25°C ~ +50°C

Certificates and Standards



IEC 60598-2-22,
IEC55015,
IEC61000-3-2,
IEC61000-3-3
IEC62778

Controls and Dimming

Dimmable	NFC dimmable
Intelligent Control	DALI-2 option, CBS address card option

Mechanical and Housing

Structure Material	Aluminum-Alloy Die Castings
Finish Material	Powder coated
Lens Material	Tampered glass
Fixture Color	Silver grey RAL9006
Mounting Option	Wall mounted (+5° to -15°)



ilumen

📍 Address: Am Hopfenbach 12, 22926 Ahrensburg, Germany

☎ +49 4102 7798707

✉ info@ilumenled.de

🌐 www.ilumenled.de



★ All the specifications are subject to change without notification,
please contact us prior to ordering.

V1.0
2025-04