

ilumen



Agnes

The next generation of post light

WE MAKE IT
Light
GERMAN QUALITY · DEUTSCHE QUALITÄT

GENERAL

- Suitable for Walkway, Park, Village, Garden.
- Variety of installation: Horizontal and Suspend, to meet the needs of different applications.
- High Color Rendering Index, Flicker free.
- Various light distribution lens with tempered glass.
- Power selectable & CCT selectable
- IP65, IK09, to match outdoor condition.
- Suitable for 42-76mm light pole, standard version is 60mm.
- .ies/.ldt files are available.



Residential



Park



Country Road



ilumen



WE MAKE IT
Light
GERMAN QUALITY - DEUTSCHE QUALITÄT

VERSIONS

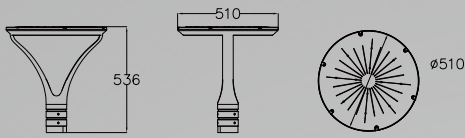

Agnes A
IL-PO29A-NXXX2C-XXX

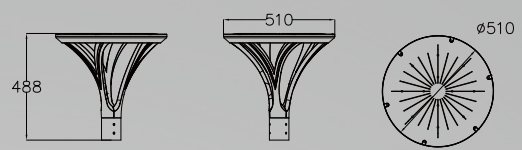

Agnes B
IL-PO29B-NXXX2C-XXX

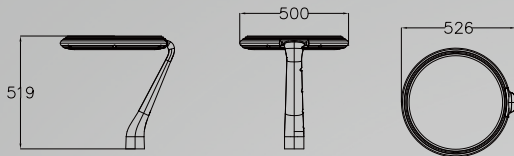

Agnes C
IL-PO29C-NXXX2C-XXX

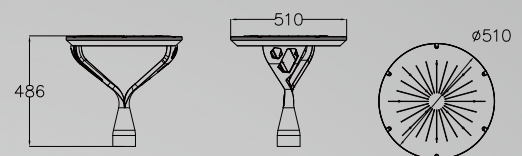

Agnes D
IL-PO29D-NXXX2C-XXX

40W/65W selectable

PRODUCT DATA

Light and Electrical

LED Chip	Lumileds
Light Efficacy	150lm/w
CCT	3000K/4000K selectable
CRI	>70 (80 optional)
LED Lifespan	80,000Hrs@L80B10 (Ta 25Deg)
Driver	Philips
Input voltage	220-240Vac
Input Frequency	50/60Hz
Inrush current	-
Power Factor	>0.95
THD	<15%
SPD	Osram 10KV
CLASS	I

Controls and Dimming

Dimmable	Optional
Intelligent Control	1-10V dimming/DALI/Microwave sensor

Mechanical and Housing

Structure Material	Die casting ADC12
Finish Material	Power coated paint RAL9017
Lens Material	(PC)Polycarbonate
Glass Material	Tempered glass
Ingress protection code	IP65
Mech. impact protection	IK09

Photometric distributions

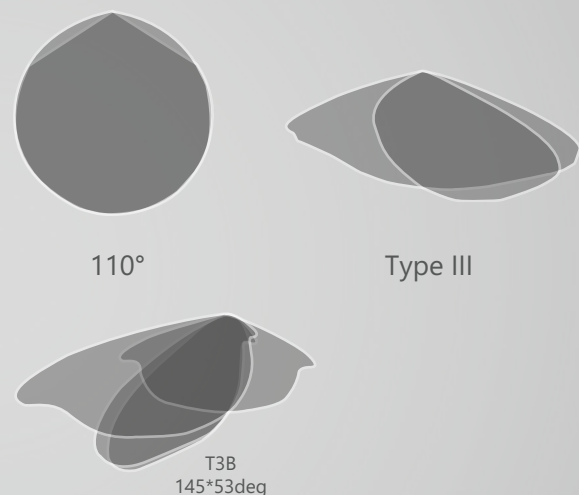

Operating Temperature

Operating Temperature -30°C~50°C

Certificates and Standards



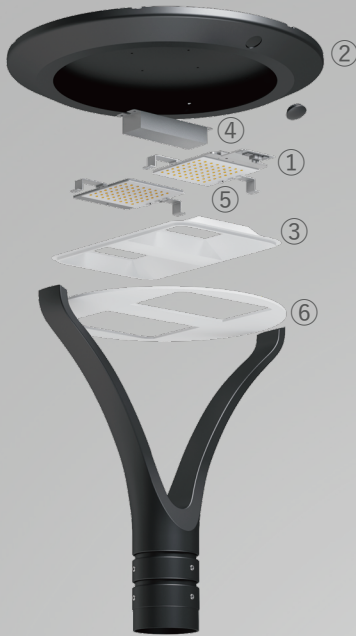

①: Plastic plug: Used to cover power & color temperature selectable switch.

②: Housing: Made of die-cast aluminum, it has excellent heat dissipation performance.

③: Reflective paper: Make the lighting effect of the lamps better and more uniform.

④: Driver & switch: To make it more user-friendly, Agnes is preset with power and color temperature settings. Users can select their desired power and color temperature individually via the switch.

⑤: Professional PCB with good heat conduction.

⑥: Tempered glass: Featuring strong impact resistance, high temperature tolerance, and enhanced safety, it also effectively prevents glare and UV radiation.

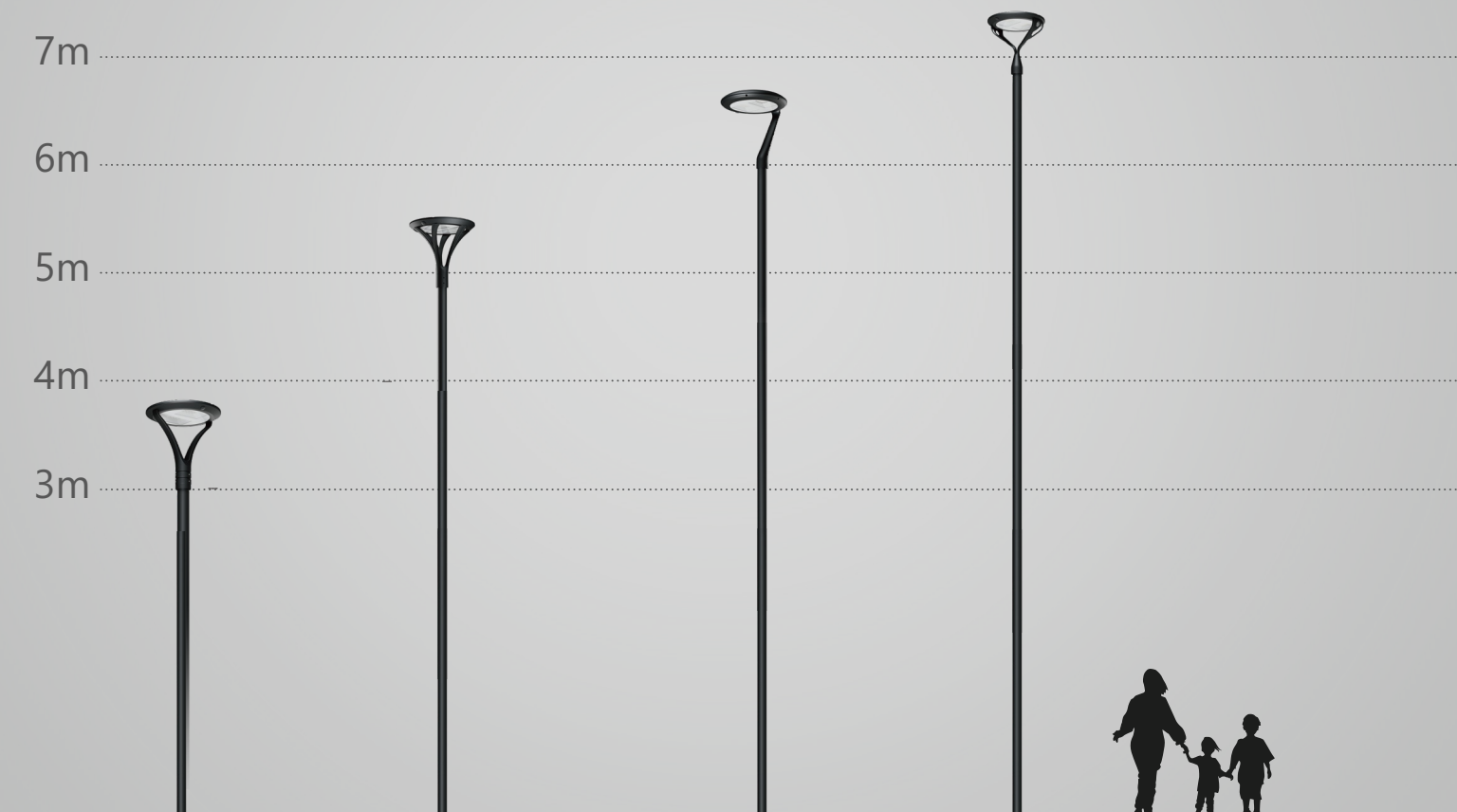

WE MAKE IT
Light



GERMAN QUALITY · DEUTSCHE QUALITÄT

ilumen

📍 Address: Am Hopfenbach 12, 22926 Ahrensburg, Germany

☎ Phone: +49 4102 7798707

✉ email: info@ilumenled.de

🌐 www.ilumenled.de